

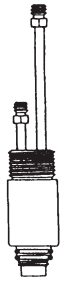









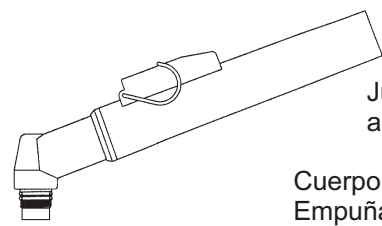
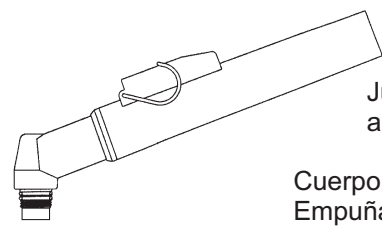





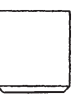
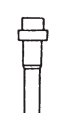
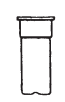







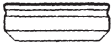
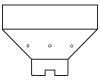
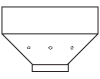







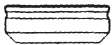



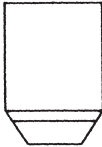





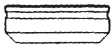









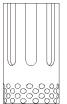

Codigo	N° Pedido	Descripción	
<b>Recambios adecuados a Hypertherm® Max® 40 / HT® 40 (PAC 140)</b>			
057112 057113 057053 057054	HG 1226 HG 1285 HG 1227 HG 1286	Antorcha manual, 25' - 7,5 m (1/2 - 20 conexión) ..... Antorcha manual, 50' - 15,0 m (1/2 - 20 conexión) ..... Antorcha automatica, 25' - 7,5 m con cables aislados ... Antorcha automatica, 50' - 15,0 m con cables aislados ...	
	HG 1206 HG 1207 HG 1208 HG 1209	 Cables, 25' - 7,5 m (antorcha manual) ..... Cables, 50' - 15,0 m (antorcha manual) ..... Cables, 25' - 7,5 m (antorcha automatica) aislados ..... Cables, 50' - 15,0 m (antorcha automatica) aislados .....	
020206 020114	HG 1229F HG 1229	 Empuñadura automatica ..... Cuerpo antorcha automatica .....	
026016	HG 1221	 Junta tórica adecuada al cuerpo antorcha automatica y manual ...	
057114	HG 1228	 Cuerpo antorcha manual completo con Empuñadura y micro .....	
020103	HG 1021	 Electrodo Hafnium .....	
020101	HG 1225	 Difusor Aire VESPEL® .....	
020115	HG 1003	 Boquilla (antorcha manual) .....	
020131	HG 1004	 Boquilla cónica (antorcha automatica) .....	
020102	HG 1222	 Boquilla (antorcha automatica) .....	
020104	HG 1220	 Portaboquilla .....	
020467	HG 1025	 Electrodo larga Hafnium .....	
020466	HG 1023	 Boquilla larga.....	
020200	HG 1224	 Portaboquilla .....	
<p style="text-align: center;">Para los correspondientes kit compás antorcha y accesorios véase pág. 3.</p> <p style="text-align: center;">Los nombres "Hypertherm" e "Max" quedan registrados en Hypertherm Inc. N.H. USA. Estos vienen por nosotros nombrados solo como referencia.</p> <p style="text-align: center;">© Copyright 2009 by HOLMA® Switzerland. Todos los derechos reservados.</p>			

Codigo	N° Pedido	Descripción	
<b>Recambios adecuados a Hypertherm® Powermax 600® (PAC123T/M)</b>			
120576	HG 12311	 Difusor Aire Vespel® .....	
120573	HG 12300	 Electrodo Hafnium, long life....(HOLMA Design)..... (Sostituye 020351)	
120826	HG 12342	 Boquilla 40 Amp .....	
120574	HG 12303	 Electrodo largo Hafnium .....(HOLMA Design)..... (Sostituye 020547)	
120606	HG 12313	 Boquilla cónica alargada 35 Amp PAC 123 T .....	
120600	HG 12315	 Portaboquilla contacto PAC 123 T/M (HOLMA Design).....	
120303	HG 3111/1	 Anillo fijación portapatin PAC 123 T/M ..... (HOLMA Design)	
120828	HG 12340	 Distanciador contacto manual PAC 123 T/M ..... (HOLMA Design)	
120827	HG 12341	 Distanciador contacto automatico PAC 123 T/M ..... (HOLMA Design)	
<b>Para el correspondiente kit compás antorcha y accesorios véase pág. 3.</b>			
Los nombres "Hypertherm" e "Max" quedan registrados en Hypertherm Inc. N.H. USA. Estos vienen por nosotros nombrados solo como referencia.			
© Copyright 2009 by HOLMA® Switzerland. Todos los derechos reservados.			

Codigo	N° Pedido	Descripción	
<b>Recambios adecuados a Hypertherm® Powermax 800® (PAC121TS/M)</b>			
020361	HG 1260		Difusor Aire Vespel® .....
120573	HG 12300		Electrodo Hafnium, long life..... (Sostituye 020351)
120438	HG 12301		Boquilla 40 Amp PAC 121T/M .....
120282	HG 12302		Boquilla 50 Amp PAC 121T/M .....
020395	HG 1212		Boquilla 50 Amp PAC 121 T .....
120574	HG 12303		Electrodo largo Hafnium..... (Sostituye 020547)
120305	HG 12305		Boquilla cónica alargada PAC 121 T/M .....
120304	HG 12304		Boquilla larga PAC 121 T .....
120301	HG 12306		Portaboquilla contacto PAC 121 T/M (HOLMA Design) .....
	HG 3111		Anillo fijación portapatin..(HOLMA Design) .....
	HG 12309		Muelle patin .....
120283	HG 12307		Distanciador contacto manual .....
			.....(HOLMA Design).....
120326	HG 12308		Distanciador automatico .....
			.....(HOLMA Design).....
020930	HG 1257		Portaboquilla...(HOLMA Design) .....
Para el correspondiente kit compás antorcha y accesorios véase pág. 3.			
Los nombres "Hypertherm" y "Max" quedan registrados en Hypertherm Inc. N.H. USA. Estos vienen por nosotros nombrados solo como referencia.			
© Copyright 2009 by HOLMA® Switzerland. Todos los derechos reservados.			

Codigo	N° Pedido	Descripción
<b>Recambios adecuados a Hypertherm® Powermax 900® (PAC125T/M)</b>		
120576	HG 12311	 Difusor Aire Vespel® .....
120573	HG 12300	 Electrodo Hafnium, long life..... (Sostituye 020351)
120577	HG 12312	 Boquilla 55 Amp PAC 125 T/M .....
120574	HG 12303	 Electrodo largo Hafnium..... (Sostituye 020547)
120606 120578	HG 12313 HG 12314	 Boquilla cónica alargada 35 Amp PAC 125 T ..... Boquilla larga 55 Amp PAC 125 T .....
120600	HG 12315	 Portaboquilla contacto PAC 125 T/M ..... (HOLMA Design) .....
120303	HG 3111/1	 Anillo fijación portapatín PAC 125 T/M ..... (HOLMA Design)
120601	HG 12307	 Distanciador contacto manual PAC 125 T ..... .....(HOLMA Design).....
120602	HG 12308	 Distanciador automatico PAC 125 M ..... .....(HOLMA Design).....
<p>Para los correspondientes kit compás antorcha y accesorios véase pág. 3.</p> <p>Los nombres "Hypertherm" y "Max" quedan registrados en Hypertherm Inc. N.H. USA. Estos vienen por nosotros nombrados solo como referencia.</p> <p>© Copyright 2009 by HOLMA® Switzerland. Todos los derechos reservados.</p>		

Codigo	N° Pedido	Descripción
<b>Recambios adecuados a Hypertherm®            Powermax 1000/1100/1250/1650®, T60/T60M®,            RT60/RT60M®, T80/T80M®, RT80/RT80M®, T100/T100M®</b>		
120925	HG 12350	 Difusor aire Vespel® (40-80A).....
120926	HG 12351	 Electrodo Hafnium (40-80A).....
120932 120931 120927	HG 12355 HG 12356 HG 12357	 Boquilla 40A .....  Boquilla 60A .....  Boquilla 80A .....
220329	HG 12358	 Boquilla FineCut Cromo T60/T80/T100.....
220006	HG 12359	 Boquilla larga 40 Amp. <b>Nuevo!!</b> .....
220007 120980	HG 12349 HG 12348	 Boquilla larga 60 Amp. <b>Nuevo!!</b> .....  Boquilla larga 80 Amp. <b>Nuevo!!</b> .....
120928	HG 12352	 Portaboquilla (40-80A).....
120929	HG 12353	 Distanciador contacto (corte manual 40-80A)..... (HOLMA Design)
120930	HG 12354	 Distanciador corte automatico 40-80A ..... (HOLMA Design)
220051	HG 12360	 Difusor aire Vespel® (100A).....
220037	HG 12361	 Electrodo Hafnium (100A).....
220011	HG 12365	 Boquilla 100A .....
220048	HG 12362	 Portaboquilla (100A).....
220065	HG 12363	 Distanciador contacto (corte manual 100A)..... (HOLMA Design)
220047	HG 12364	 Distanciador corte automatico 100A ..... (HOLMA Design)

Recambios adecuados a  
Hypertherm® MAX® 80 / 100 (PAC 130)

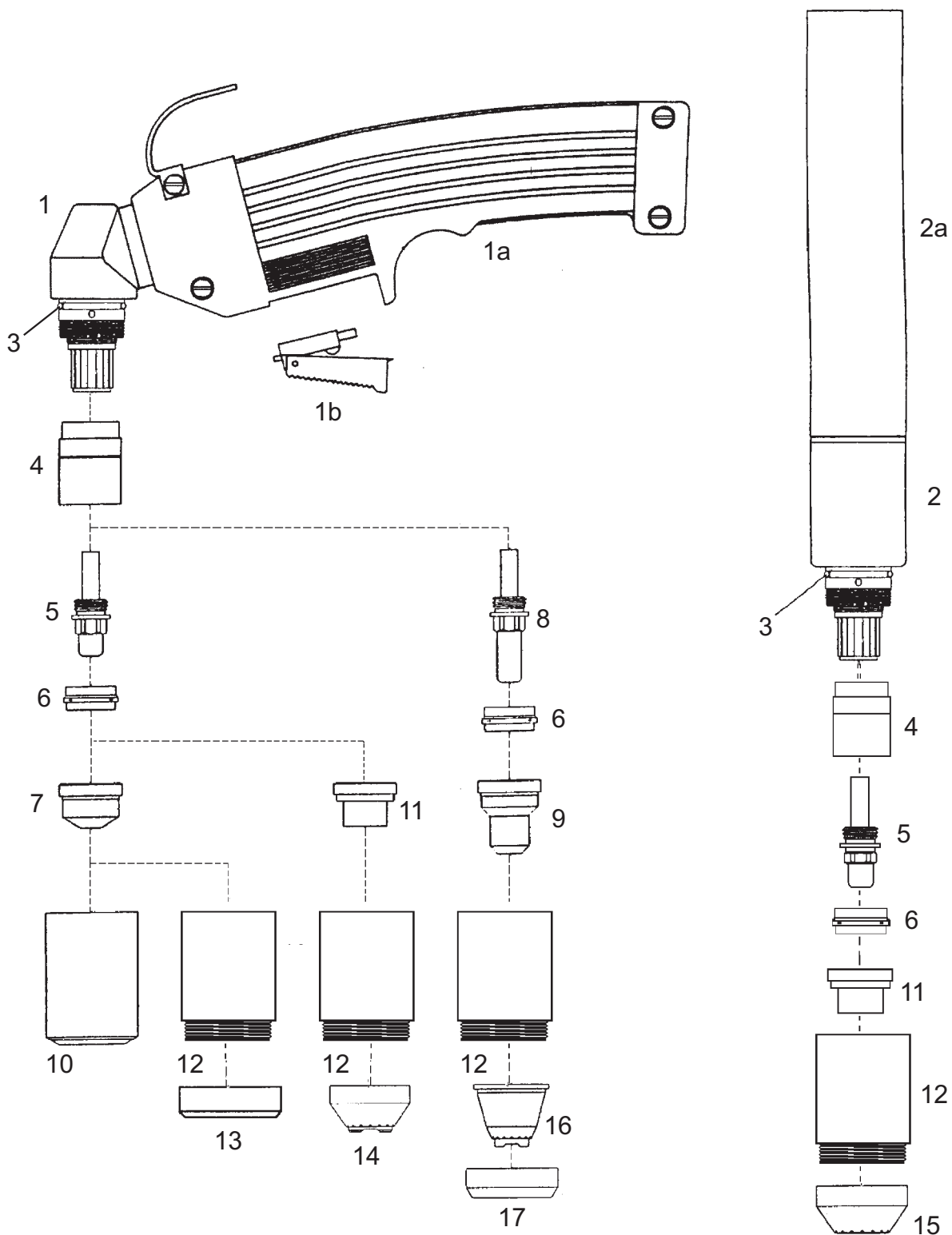















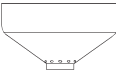

Los nombres "Hypertherm" e "Max" quedan registrados en Hypertherm Inc. N.H. USA.  
Estos vienen por nosotros nombrados solo como referencia.

N°	Codigo	N° Pedido	Descripción
	059076	HG 1245	Antorcha manual completo 25' - 7,5 m (1/2 - 20 conexión) .....
	059077	HG 1246	Antorcha manual completa 50' - 15,0 m (1/2 - 20 conexión) .....
	059008	HG 1247	Antorcha automatica completa 25' - 7,5 m (1/2 - 20 con cables aislados)
	059009	HG 1248	Antorcha automatica completa 50' -15,0 m (1/2 - 20 con cables aislados)
		HG 1258	Cables 25' - 7,5 m (1/2 - 20 conexión) antorcha manual .....
		HG 1259	Cables 50' - 15,0 m (1/2 - 20 conexión) antorcha manual .....
		HG 1261	Cables 25' - 7,5 m (1/2 - 20 conexión) aislados antorcha automatica.....
		HG 1262	Cables 50' - 15,0 m (1/2 - 20 conexión) aislados antorcha automatica.....
1	020189	HG 1242	Cuerpo antorcha manual con empuñadura y micro .....
1a		HG 1026/5	Empuñadura completa con micro .....
1b		HG 1026/6	Micro .....
2	020201	HG 1243	Cuerpo antorcha automatica .....
2a	020245	HG 3009	Empuñadura automatica .....
3	026018	HG 2648	Junta tórica .....
4		HG 1043V	Aislante anterior VESPEL® .....
5	120433	HG 1230	Electrodo Hafnium, long life (codigo viejo N° 020191) .....
6	020194	HG 1231	Difusor Aire VESPEL® .....
7	020203	HG 1232	Boquilla Ø 1,0 mm -.038 40 Amp .....
	020345	HG 1233	Boquilla Ø 1,3 mm -.052 80 Amp .....
	020195	HG 1234	Boquilla Ø 1,5 mm -.059 100 Amp .....
	020705	HG 1254	Boquilla 100 Amp adecuada a Hypertherm® MAX100D .....
8	020564	HG 1239	Electrodo larga, Hafnium .....
9		HG 12401	Boquilla larga Ø 1,0 mm -.038 .....
	020563	HG 1240	Boquilla larga Ø 1,4 mm -.055 .....
10	020184	HG 1235	Portaboquilla .....
11	020396	HG 1293	Boquilla contacto Ø 1,0 mm -.038 40 Amp .....
	020397	HG 1241	Boquilla contacto Ø 1,3 mm -.052 80 Amp .....
	020337	HG 1284	Boquilla contacto Ø 1,5 mm -.059 100 Amp .....
12		HG 1237	Portaboquilla contacto long life HOLMA-Design .....
	020336	HG 1292	Portaboquilla contacto con VESPEL® HOLMA-Design .....
13	020333	HG 1253	Anillo de fijación .....
14	020335	HG 1295	Distanciador contacto manual HOLMA-Design .....
15	020334	HG 1298	Protección antorcha automatica HOLMA-Design .....
16		HG 1296	Distanciador contacto manual (para boquillas largas fig. N°11) .....
17		HG 1297	Tuerca tapón .....

Los nombres "Hypertherm" e "Max" quedan registrados en Hypertherm Inc. N.H. USA.  
Estos vienen por nosotros nombrados solo como referencia.

© Copyright 2009 by HOLMA® Switzerland. Todos los derechos reservados.

Codigo	N° Pedido	Descripción	
<b>Recambios adecuados a Hypertherm® Max 200®, PAC200T/E und HT 2000®</b>			
120547 120667 120667 020415	HG 30134 HG 30035 HG 30035/B HG 30133	 <p><b>Nuevo!!</b> Electrodo - Oxigeno 100A ..... Electrodo - Oxigeno 200A (sost. 020664/020414/220021)..... Electrodo - Oxigeno 200A <b>HOLMA BLUE LINE</b> ..... Electrodo - Ar/H 200A .....</p>	
020689	HG 30074	 <p>Boquilla - .038, 40 Amp Aire .....</p>	
020616 020611	HG 30062 HG 30058	 <p>Boquilla - .055, 100 Amp Oxigeno (MAX 200®) ..... Boquilla - .059, 100 Amp Aire/Nitrógeno .....</p>	
020605 020608 020690 020615	HG 30055 HG 30057 HG 30075 HG 30112	 <p>Boquilla - .082, 200 Amp Oxigeno ..... Boquilla - .086, 200 Amp Aire/Nitrógeno ..... Boquilla - .055, 100 Amp Oxigeno (HT 2000®) ..... Boquilla scar Aire 200A .....</p>	
020423	HG 30040	 <p>Portaboquilla .....</p>	
020424 020448	HG 30041 HG 30045	 <p>Protección - .086, 200 Amp, antorcha automatica ..... Protección - .059, 100 Amp, antorcha automatica .....</p>	
<b>Recambios adecuados a Hypertherm® Hyspeed® HT 2000®</b>			
220235	HG 30150	 <p>Electrodo 200A O<sub>2</sub> .....</p>	
220237	HG 30155	 <p>Boquilla 200A O<sub>2</sub> .....</p>	
220238	HG 30158	 <p>Portaboquilla 200A O<sub>2</sub> .....</p>	
220239	HG 30159	 <p>Protección 200A O<sub>2</sub> .....</p>	
<p style="text-align: center;">Los nombres "Hypertherm" e "Max" quedan registrados en Hypertherm Inc. N.H. USA. Estos vienen por nosotros nombrados solo como referencia. © Copyright 2009 by HOLMA® Switzerland. Todos los derechos reservados.</p>			

Codigo	N° Pedido	Descripción	
<b>Recambios adecuados a Hypertherm® Max® 40CS, Max® 42, Max® 43 (PAC 121PT/M)</b>			
020361	HG 1260	 Difusor Aire VESPEL® .....	
120573	HG 12300	 Electrodo Hafnium, long life..(HOLMA Design) ..... (Codigo viejo N°020351)	
020350	HG 1211	 Boquilla Ø 0,96 - .038 ..... Boquilla Ø 1,06 - .042 .....	
020395	HG 1212		
020542	HG 1218	 Boquilla cónica .....	
120574	HG 12303	 Electrodo largo Hafnium..(HOLMA Design) ..... (Codigo viejo N°020547)	
020546	HG 1214	 Boquilla larga Ø 0,96 - .038 .....	
020930	HG 1257	 Portaboquilla .....	