

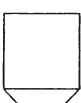

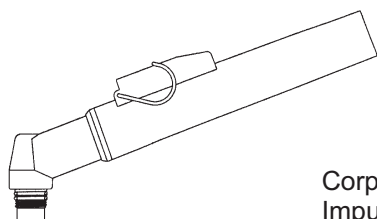

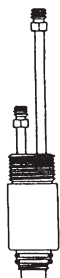









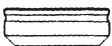
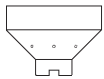
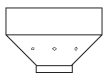







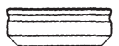



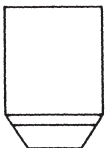





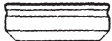





Codice	N° Articolo	Descrizione
Ricambi compatibili con Hypertherm® Max® 40 / HT® 40 (PAC 140)		
057112	HG 1226	Torcia manuale, 25' - 7,5 m (1/2 - 20 raccordo)
057113	HG 1285	Torcia manuale, 50' - 15,0 m (1/2 - 20 raccordo)
057053	HG 1227	Torcia automatica, 25' - 7,5 m con cavi isolati.....
057054	HG 1286	Torcia automatica, 50' - 15,0 m con cavi isolati.....
	HG 1206	Fascio cavi, 25' - 7,5 m (per torcia manuale)
	HG 1207	Fascio cavi, 50' - 15,0 m (per torcia manuale)
	HG 1208	Fascio cavi, 25' - 7,5 m (Torcia autom.) isolati.....
	HG 1209	Fascio cavi, 50' - 15,0 m (Torcia autom.) isolati.....
020206	HG 1229F	Tubo di posizionamento.....
020114	HG 1229	Corpo torcia automatica.....
026016	HG 1221	O-ring compatibile con corpo torcia automatica e manuale...
057114	HG 1228	Corpo torcia manuale completo di Impugnatura e pulsante.....
020103	HG 1021	Elettrodo Hafnium
020101	HG 1225	Diffusore Aria VESPEL®
020115	HG 1003	Ugello (Torcia manuale)
020131	HG 1004	Ugello conico (torcia automatica)
020102	HG 1222	Ugello (torcia automatica)
020104	HG 1220	Portaugello
020467	HG 1025	Elettrodo lungo Hafnium
020466	HG 1023	Ugello lungo.....
020200	HG 1224	Portaugello
Per il relativo kit compasso per torcia e accessori vedere pagina 3.		
I nomi "Hypertherm" e "Max" sono registrati presso la Hypertherm Inc. N.H. USA. Tali nomi vengono da noi utilizzati solo come mero riferimento.		
© Copyright 2009 by HOLMA® Switzerland. Tutti i diritti riservati.		



Codice	N° Articolo	Descrizione
Ricambi compatibili con Hypertherm® Powermax 600® (PAC123T/M)		
120576	HG 12311	 Diffusore Aria Vespel®.....
120573	HG 12300	 Elettrodo Hafnium, long life..... (Sostituisce 020351)
120826	HG 12342	 Ugello 40 Amp.....
120574	HG 12303	 Elettrodo lungo Hafnium..... (Sostituisce 020547)
120606	HG 12313	 Ugello conico prolungato 35 Amp PAC 123 T.....
120600	HG 12315	 Boccola portaugello taglio a contatto PAC 123 T/M (HOLMA Design).....
120303	HG 3111/1	 Ghiera portamolle PAC 123 T/M (HOLMA Design).....
120828	HG 12340	 Distanziale taglio a contatto manuale..... PAC 123 T/M.....(HOLMA Design).....
120827	HG 12341	 Protezione torcia automatica..... PAC 123 T/M.....(HOLMA Design).....
Per il relativo kit compasso per torcia e accessori vedere pagina 3.		
I nomi "Hypertherm" e "Max" sono registrati presso la Hypertherm Inc. N.H. USA. Tali nomi vengono da noi utilizzati solo come mero riferimento.		
© Copyright 2009 by HOLMA® Switzerland. Tutti i diritti riservati.		

Codice	N° Articolo	Descrizione	
Ricambi compatibili con Hypertherm® Powermax 800® (PAC121TS/M)			
020361	HG 1260		Diffusore Aria Vespel®.....
120573	HG 12300		Elettrodo Hafnium, long life..... (Sostituisce 020351)
120438 120282	HG 12301 HG 12302		Ugello 40 Amp PAC 121T/M..... Ugello 50 Amp PAC 121T/M.....
020395	HG 1212		Ugello 50 Amp PAC 121 T.....
120574	HG 12303		Elettrodo lungo Hafnium..... (Sostituisce 020547)
120305	HG 12305		Ugello conico prolungato PAC 121 T/M.....
120304	HG 12304		Ugello lungo PAC 121 T.....
120301	HG 12306		Boccola portaugello taglio a contatto PAC 121 T/M (HOLMA Design).....
	HG 3111		Ghiera portamolle.....(HOLMA Design).....
	HG 12309		Distanziale a molla.....
120283	HG 12307		Distanziale taglio a contatto manuale.....(HOLMA Design).....
120326	HG 12308		Protezione torcia automatica.....(HOLMA Design).....
020930	HG 1257		Portaugello.....(HOLMA Design).....
Per il relativo kit compasso per torcia e accessori vedere pagina 3.			
I nomi "Hypertherm" e "Max" sono registrati presso la Hypertherm Inc. N.H. USA. Tali nomi vengono da noi utilizzati solo come mero riferimento.			
© Copyright 2009 by HOLMA.® Switzerland. Tutti i diritti riservati.			

Codice	N° Articolo	Descrizione
Ricambi compatibili con Hypertherm® Powermax 900® (PAC125T/M)		
120576	HG 12311	 Diffusore Aria Vespel®.....
120573	HG 12300	 Elettrodo Hafnium, long life..... (Sostituisce 020351)
120577	HG 12312	 Ugello 55 Amp PAC 125 T/M.....
120574	HG 12303	 Elettrodo lungo Hafnium..... (Sostituisce 020547)
120606 120578	HG 12313 HG 12314	 Ugello conico prolungato 35 Amp PAC 125 T..... Ugello lungo 55 Amp PAC 125 T
120600	HG 12315	 Boccola portaugello taglio a contatto PAC 125 T/M. (HOLMA Design).....
120303	HG 3111/1	 Ghiera portamolle PAC 125 T/M (HOLMA Design)..
120601	HG 12307	 Distanziale taglio a contatto manuale..... PAC 125 T.....(HOLMA Design).....
120602	HG 12308	 Protezione torcia automatica..... PAC 125 M(HOLMA Design).....
Per il relativo kit compasso per torcia e accessori vedere pagina 3.		
I nomi "Hypertherm" e "Max" sono registrati presso la Hypertherm Inc. N.H. USA. Tali nomi vengono da noi utilizzati solo come mero riferimento.		
© Copyright 2009 by HOLMA® Switzerland. Alle Rechte vorbehalten.		

Codice	N° Articolo	Descrizione
Ricambi compatibili con Hypertherm® Powermax 1000/1100/1250/1650®, T60/T60M®, RT60/RT60M®, T80/T80M®, RT80/RT80M®, T100/T100M®		
120925	HG 12350	 Diffusore aria Vespele® (40-80A).....
120926	HG 12351	 Elettrodo Hafnium (40-80A).....
120932	HG 12355	Ugello 40A
120931	HG 12356	Ugello 60A
120927	HG 12357	Ugello 80A
220329	HG 12358	 Ugello FineCut Cromo T60/T80/T100.....
220006	HG 12359	Ugello lungo 40 Amp. ... Nuovo!!
220007	HG 12349	Ugello lungo 60 Amp. ...
120980	HG 12348	Ugello lungo 80 Amp. ... Nuovo!!
120928	HG 12352	 Portaugello (40-80A).....
120929	HG 12353	 Distanziale taglio a contatto (taglio manuale 40-80A)..... (HOLMA Design)
120930	HG 12354	 Protezione (taglio automatico 40-80A)..... (HOLMA Design)
220051	HG 12360	 Diffusore aria Vespele® (100A).....
220037	HG 12361	 Elettrodo Hafnium (100A).....
220011	HG 12365	 Ugello 100A
220048	HG 12362	 Portaugello (100A).....
220065	HG 12363	 Distanziale taglio a contatto (taglio manuale 100A)..... (HOLMA Design)
220047	HG 12364	 Protezione (taglio automatico 100A)

Ricambi compatibili con
Hypertherm® MAX® 80 / 100 (PAC 130)

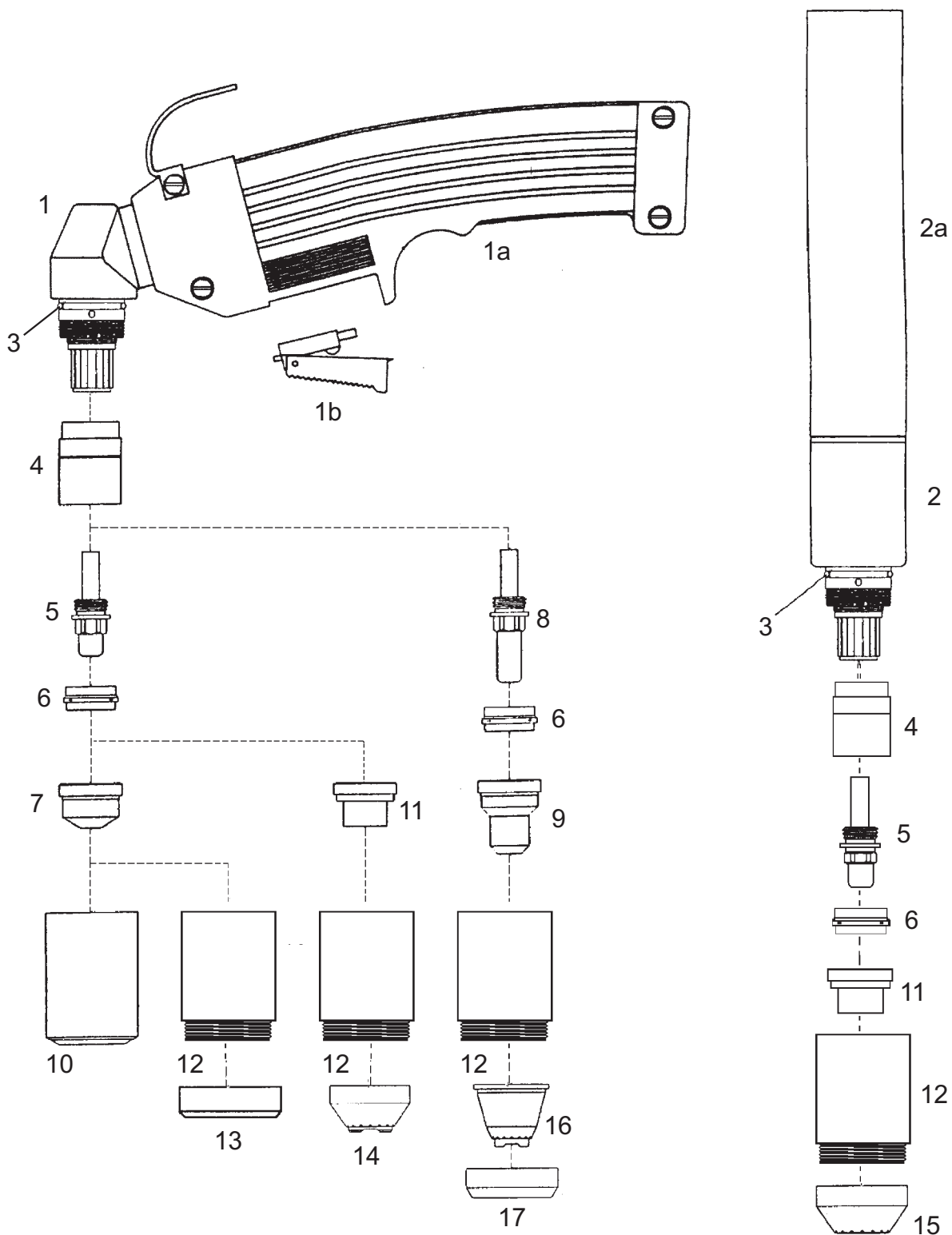













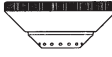

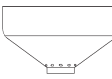

I nomi "Hypertherm" e "Max" sono registrati presso la Hypertherm Inc. N.H. USA.
Tali nomi vengono da noi utilizzati solo come mero riferimento.

N°	Codice	N° Articolo	Descrizione
	059076	HG 1245	Torcia manuale completo 25' - 7,5 m (1/2 - 20 raccordo).....
	059077	HG 1246	Torcia manuale completa 50' - 15,0 m (1/2 - 20 raccordo).....
	059008	HG 1247	Torcia automatica completa 25' - 7,5 m (1/2 - 20 con cavi isolati).....
	059009	HG 1248	Torcia automatica completa 50' - 15,0 m (1/2 - 20 con cavi isolati).....
		HG 1258	Fascio cavi 25' - 7,5 m (1/2 - 20 raccordo) per torcia manuale.....
		HG 1259	Fascio cavi 50' - 15,0 m (1/2 - 20 raccordo) per torcia manuale.....
		HG 1261	Fascio cavi 25' - 7,5 m (1/2 - 20 raccordo) isolati per torcia automatica.....
		HG 1262	Fascio cavi 50' - 15,0 m (1/2 - 20 raccordo) isolati per torcia automatica.....
1	020189	HG 1242	Corpo torcia manuale con impugnatura e pulsante.....
1a		HG 1026/5	Impugnatura completa con pulsante.....
1b		HG 1026/6	Pulsante.....
2	020201	HG 1243	Corpo torcia automatica.....
2a	020245	HG 3009	Tubo di posizionamento.....
3	026018	HG 2648	O - ring.....
4		HG 1043V	Isolatore anteriore VESPEL®.....
5	120433	HG 1230	Elettrodo Hafnium, long life (vecchio codice N° 020191).....
6	020194	HG 1231	Diffusore Aria VESPEL®.....
7	020203	HG 1232	Ugello Ø 1,0 mm -.038 40 Amp.....
	020345	HG 1233	Ugello Ø 1,3 mm -.052 80 Amp.....
	020195	HG 1234	Ugello Ø 1,5 mm -.059 100 Amp.....
	020705	HG 1254	Ugello 100 Amp compatibile con Hypertherm® MAX100D.....
8	020564	HG 1239	Elettrodo lungo, Hafnium.....
9		HG 12401	Ugello lungo Ø 1,0 mm -.038
	020563	HG 1240	Ugello lungo Ø 1,4 mm -.055
10	020184	HG 1235	Portaugello.....
11	020396	HG 1293	Ugello per contatto Ø 1,0 mm -.038 40 Amp.....
	020397	HG 1241	Ugello per contatto Ø 1,3 mm -.052 80 Amp.....
	020337	HG 1284	Ugello per contatto Ø 1,5 mm -.059 100 Amp.....
12		HG 1237	Boccola per contatto ugello long life HOLMA-Design.....
	020336	HG 1292	Boccola per contatto con VESPEL® HOLMA-Design.....
13	020333	HG 1253	Ghiera di protezione.....
14	020335	HG 1295	Distanziale taglio manuale a contatto HOLMA-Design.....
15	020334	HG 1298	Protezione torcia automatica HOLMA-Design.....
16		HG 1296	Protezione taglio a contatto manuale (per ugelli lunghi fig. N°11).....
17		HG 1297	Ghiera di bloccaggio.....

I nomi "Hypertherm" e "Max" sono registrati presso la Hypertherm Inc. N.H. USA.
Tali nomi vengono da noi utilizzati solo come mero riferimento.

© Copyright 2009 by HOLMA® Switzerland. Tutti i diritti riservati.

Codice	N° Articolo	Descrizione	
Ricambi compatibili con Hypertherm® Max 200®, PAC200T/E und HT 2000®			
120547 120667 120667 020415	HG 30134 HG 30035 HG 30035/B HG 30133	 <p>Elettrodo - Ossigeno 100A..... Elettrodo - Ossigeno 200A (sost. 020664/020414/220021).. Elettrodo - Ossigeno 200A HOLMA BLUE LINE Elettrodo - Ar/H 200A.....</p>	
020689	HG 30074	 <p>Ugello - .038, 40 Amp Aria.....</p>	
020616 020611	HG 30062 HG 30058	 <p>Ugello - .055, 100 Amp Ossigeno (MAX 200®)..... Ugello - .059, 100 Amp Aria/Azoto</p>	
020605 020608 020690 020615	HG 30055 HG 30057 HG 30075 HG 30112	 <p>Ugello - .082, 200 Amp Ossigeno..... Ugello - .086, 200 Amp Aria/Azoto..... Ugello - .055, 100 Amp Ossigeno (HT 2000®)..... Ugello scricatura Aria 200A</p>	
020423	HG 30040	 <p>Portaugello</p>	
020424 020448	HG 30041 HG 30045	 <p>Protezione - .086, 200 Amp, torcia automatica..... Protezione - .059, 100 Amp, torcia automatica.....</p>	
Ricambi compatibili con Hypertherm® Hyspeed® HT 2000®			
220235	HG 30150	 <p>Elettrodo 200A O₂.....</p>	
220237	HG 30155	 <p>Ugello 200A O₂.....</p>	
220238	HG 30158	 <p>Portaugello 200A O₂.....</p>	
220239	HG 30159	 <p>Protezione 200A O₂.....</p>	
Pagina 28		<p>I nomi "Hypertherm" e "Max" sono registrati presso la Hypertherm Inc. N.H. USA. Tali nomi vengono da noi utilizzati solo come mero riferimento. © Copyright 2009 by HOLMA® Switzerland. Tutti i diritti riservati.</p>	

Codice	N° Articolo	Descrizione	
Ricambi compatibili con Hypertherm® Max® 40CS, Max® 42, Max® 43 (PAC 121PT/M)			
020361	HG 1260	 Diffusore Aria VESPEL®	
120573	HG 12300	 Elettrodo Hafnium, long life..... (Vecchio codice N°020351)	
020350 020395	HG 1211 HG 1212	 Ugello Ø 0,96 - .038..... Ugello Ø 1,06 - .042.....	
020542	HG 1218	 Ugello conico	
120574	HG 12303	 Elettrodo lungo Hafnium..... (Vecchio codice N°020547)	
020546	HG 1214	 Ugello lungo Ø 0,96 - .038	
020930	HG 1257	 Portaugello	