

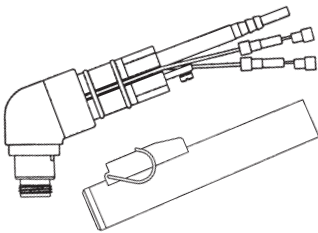

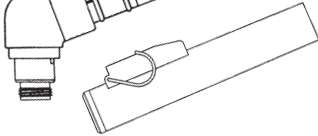









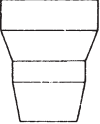
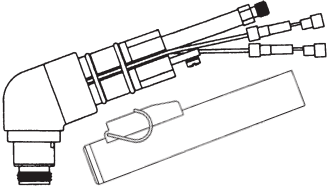



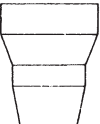
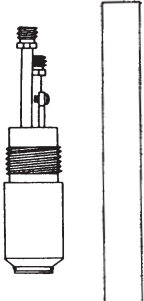
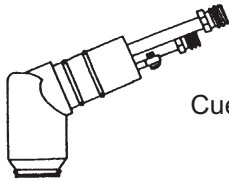
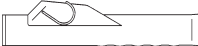





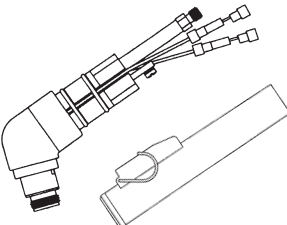





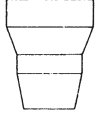

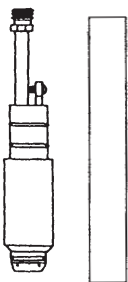
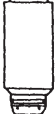
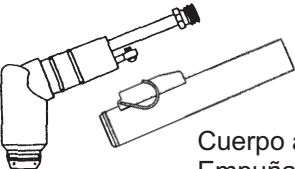





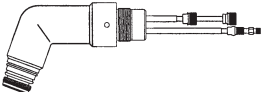
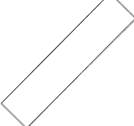

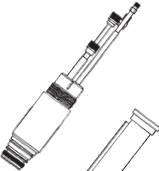



Codigo	N° Pedido	Descripción	
Recambios adecuados a Thermal Dynamics® PCH-10 Drag-Gun, Cougar 125			
	HG 14.386	Cables - eléctrico y aire - 6m	
2-1020	HG 14.385	 Antorcha manual completa con cable 6m	
9-0016 9-0019E	HG 14.063 HG 14.065	 Cuerpo antorcha manual 70° Empuñadura con microinterruptor	
8-0533	HG 1221A	Junta empuñadura	
9-6006	HG 14.007	 Electrodo Hafnium	
9-6007	HG 14.006	 Difusor Aire - Vespel®	
9-6099	HG 14.064	 Boquilla - Aire	
9-6003	HG 14.003	 Portaboquilla Para los correspondientes kit compás y accesorios véase pág. 3.	
Recambios adecuados a Thermal Dynamics® PCH-25/38 PCH-26 Pak Master 38XL, Drag-Gun 38, Econopak 50			
2-0380	HG 14.387	Antorcha manual 12.5' - 3,8 m (PCH-25/38)	
2-0381	HG 14.388	Antorcha manual 25' - 7,5 m (PCH-25/38)	
4-6067	HG 14.389	Cable antorcha manual 12,5' - 3,8 m (PCH-25/38)	
4-6068	HG 14.390	Cable antorcha manual 25' - 7,5 m (PCH-25/38)	
2-3501	HG 14.391	Antorcha manual 12.5' - 3,8 m (PCH-26)	
2-3511	HG 14.392	Antorcha manual 25' - 7,5 m (PCH-26)	
4-6071	HG 14.067	Cable antorcha manual 12,5' - 3,8 m (PCH-26)	
4-6072	HG 14.393	Cable antorcha manual 25' - 7,5 m (PCH-26)	
9-5807 9-6282E	HG 14.028 HG 14.065	 Cuerpo antorcha manual 70° Empuñadura con microinterruptor	
8-0533	HG 1221A	Junta empuñadura	
9-6506	HG 14.023	 Electrodo Hafnium, reforzado	
9-6507	HG 14.024	 Difusor Aire, reforzado	
9-6501	HG 14.026	 Boquilla (drag cut), reforzada	
9-6003	HG 14.003	 Portaboquilla Para los correspondientes kit compás y accesorios véase pág. 3.	

Codigo	N° Pedido	Descripción	
Recambios adecuados a Thermal Dynamics® PCH/M- 52 Pak-5XR*, Pak-6XR*, Pak-7XR, Pak-8XR, Pak-10-XR, Pak-625XR* Pak-750-XR*, Pak-1000XR, Pak-1250-XR *=Dual Gas			
2-2936 2-2937 2-2938 2-2939	HG 1446 HG 1447 HG 1448 HG 1449	Antorcha manual 25' - 7,5 m Antorcha manual 50' - 15,0 m Antorcha automatica 25' - 7,5 m Antorcha automatica 50' - 15,0 m	
4-5034 4-5035 4-5036 4-5037	HG 1463 HG 1464 HG 14.131 HG 14.132	 Cables antorcha manual 25' - 7,5 m Cables antorcha manual 50' - 15,0 m Cables antorcha automatica 25' - 7,5 m Cables antorcha automatica 50' - 15,0 m	
9-5643 9-7833	HG 1429 HG 14.133	Cuerpo Antorcha automatica 180° Empuñadura automatica	
8-5525 8-0536	HG 1044 HG 14.397	Junta (Portaboquilla) Junta (Empuñadura)	
9-5642	HG 1428	 Cuerpo antorcha manual 70°	
9-5644E	HG 14.319	 Empuñadura completa con micro	
8-3331 9-5619	HG 1410 HG 1410/1	 Electrodo Aria, long life Electrodo Hafnium, niquelado	
9-5702 9-5618 9-5707 9-5782 9-5708 8-5129 9-5709 9-5710 9-5713	HG 1411 HG 1412 HG 1414 HG 1420 HG 1415 HG 1427 HG 1413 HG 1416 HG 1417	 Boquilla Ø 0,90 mm - .035 35 Amp Boquilla Ø 1,10 mm - .043 45-55 Amp Boquilla Ø 1,20 mm - .047 60-70 Amp Boquilla Ø 1,32 mm - .052 80 Amp Boquilla Ø 1,50 mm - .059 105 Amp Boquilla scar  Boquilla scar Ø 1,99 mm - .078 70 A Boquilla scar Ø 2,36 mm - .093 105 A Boquilla scar Ø 2,87 mm - .113 105 A	
9-5617 9-5781 9-5799	HG 1418 HG 1426 HG 1498	 Portaboquilla, Ceramica Portaboquilla, Fenolica Portaboquilla, Metal	
9-5780	HG 1421	 Boquilla almenada - Metal (Para uso con HG 1426)	
9-5694	HG 1419	 Portaboquilla almenada - Metal	
Para el correspondiente kit compás antorcha y accesorios véase página3.			
Página 6	© Copyright 2009 by HOLMA® Switzerland. Todos los derechos reservados.		

Codigo	N° Pedido	Descripción	
Recambios adecuados a Thermal Dynamics® PCH/M-28 y PCH/M-35 Pak Master 50XL, Pak Master 50, Stak Pak			
2-5801 2-5802 4-2995 4-2996	HG 14.029 HG 14.030 HG 14.402 HG 14.403	Antorcha manual 25' - 7,5 m (PCH/M-28)..... Antorcha manual 50' - 15,0 m (PCH/M-28)..... Cables 25' - 7,5 m antorcha manual (PCH/M-28) Cables 50' - 15 m antorcha manual (PCH/M-28) ...	
8-0533 9-5807 9-6291E/8-4305E	HG 1221A HG 14.028 HG 14.065	 Junta tórica (para empuñadura) Cuerpo antorcha manual 70° Empuñadura con micro plano	
9-6006 9-6506	HG 14.007 HG 14.023	 Electrodo Hafnium (solo PCH/M - 35) Electrodo Hafnium, reforzado	
9-6007 9-6507	HG 14.006 HG 14.024	 Difusor Aire (solo PCH/M - 35) Difusor Aire, reforzado	
9-6000 9-6500 9-6002	HG 14.000 HG 14.025 HG 14.002	 Boquilla Ø 0,78 mm-.030, 35A Aire (solo PCH/M-35). Boquilla Ø 0,78 mm, reforzada Boquilla scar (solo PCH/M - 35)	
9-6001 9-6501	HG 14.001 HG 14.026	 Boquilla (drag cut - Aire) (solo PCH/M - 35) Boquilla (drag cut - Aire), reforzada	
9-6503	HG 14.027	 Portaboquilla (reforzada)..... (por uso con HG14.003)	
9-6003	HG 14.003	 Portaboquilla Std	
9-6004	HG 14.004	 Boquilla almenada (Por uso con HG14.003)	
Para el correspondiente kit compás antorcha y accesorios véase pág. 3.			
© Copyright 2009 by HOLMA® Switzerland. Todos los derechos reservados.			

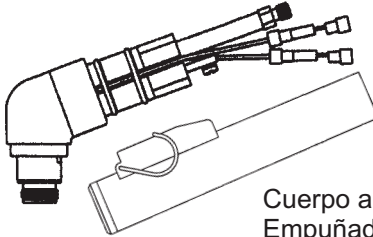
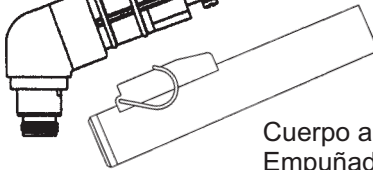
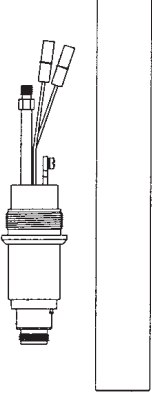
Codigo	N° Pedido	Descripción	
Recambios adecuados a Thermal Dynamics® PCH/M-51			
4Xi, 6Xi, Pak-3XR, Pak-6XR, Pak-7XR, Pak-5XT, Pak-625XR, Pak-750XR			
2-2860 2-2861 2-2864 2-2865 4-5030 4-5031 4-5032 4-5033	HG 1438 HG 1439 HG 14.127 HG 14.128 HG 1442 HG 1443 HG 14.129 HG 14.130	 Antorcha manual 25' - 7,5 m, - conexión 9/16 Antorcha manual 50' - 15,0 m, - conexión 9/16 Antorcha automatica 25' - 7,5 m Antorcha automatica 50' - 15 m Cables 25'- 7,5 m - antorcha manual Cables 50'-15,0 m - antorcha manual Cables 25'- 7,5 m - antorcha automatica Cables 50'-15,0 m - antorcha automatica.....	
9-5634 9-5637E	HG 1408 HG 14.053	 Cuerpo antorcha automatica 180° Empuñadura automatica	
8-5525 8-0533	HG 1044 HG 1221A	Junta tórica (para portaboquilla) Junta tórica (para empuñadura)	
9-5635 9-5636E	HG 1407 HG 14.065	 Cuerpo antorcha manual 70° Empuñadura completa con micro plano	
9-5633 9-5720	HG 1400 HG 1405	 Electrodo Hafnium Electrodo Hafnium (4x1)	
9-5718 9-5631 8-3321 9-5724	HG 1425 HG 1401 HG 14.401 HG 1404	 Boquilla Ø 0,96 - .038 10 - 40 A Boquilla Ø 1,10 - .043 10 - 60 A Boquilla Ø 1,20 - .047 - 65 A Boquilla scar Ø 2,00 - .078	
9-5630 8-2159	HG 1402 HG 1423	 Portaboquilla cerámica Portaboquilla, fenólica Std	
9-5779	HG 1424	 Boquilla almenada, metálica (para uso con HG1423)	
8-5526	HG 1403	 Boquilla almenada, cerámica	
Para el correspondiente kit compás antorcha y accesorios véase pág. 4.			
© Copyright 2009 by HOLMA® Switzerland. Todos los derechos reservados.			

Codigo	N° Pedido	Descripción	
Recambios adecuados a Thermal Dynamics® Maximizer 300 Merlin 1000, Merlin 3000, Merlin 6000, Merlin 6000 GST			
9-6457	HG 14.276	 Cuerpo antorcha manual 70° Cuerpo antorcha manual 90° Junta tórica	
9-6459	HG 14.277		
8-0538	HG 14.398		
9-6769	HG 14.278	 Empuñadura	
9-6767	HG 14.279	 Adaptador	
9-6410	HG 14.189	 Cuerpo antorcha automatica 180°	
7-3207	HG 14.152	 Empuñadura automatica (para Merlin 1000) Cabeza final (para Merlin 1000)	
8-4204	HG 14.102		
8-2158	HG 14.151	 Adaptador (para Merlin 1000)	
20-1010	HG 14.282	 Electrodo O2 100-225A (para 3000, 6000 & GST) Electrodo O2 100A (para 3000 & 6000) Electrodo O2 150A (para 1000, 3000 & 6000) Electrodo O2 225A (para 3000 & 6000) Electrodo Aria/O2 50-225A (para todos los tipos) Electrodo Aria/O2 300A (para 3000, 6000 & GST) Electrodo N2 50-300A (para todos los tipos) Electrodo Ar/H2 100-300A (para todos los tipos)	
20-1015	HG 14.283		
20-1016	HG 14.284		
20-1017	HG 14.285		
20-1018	HG 14.261		
20-1021	HG 14.286		
20-1023	HG 14.287		
20-1025	HG 14.288		
20-0008	HG 14.306		 Difusor Aire 50-225 A (para todos los tipos) Difusor Aire 300 A (para 3000, 6000 & GST)
20-1009	HG 14.291		
20-1030	HG 14.292	 Boquilla 50 A O2/N2/Air (para todos los tipos) Boquilla 100 A O2/N2/Air (para todos los tipos) Boquilla 150 A (para 3000, 6000 & GST) Boquilla 225 A (para 3000, 6000 & GST) Boquilla 300 A (para todos los tipos)	
20-1031	HG 14.293		
20-1032	HG 14.294		
20-1033	HG 14.295		
20-1034	HG 14.296		
20-1002	HG 14.308	 Portaboquilla (para todos los tipos) Portaboquilla Underwater (para 1000, 6000 & GST)	
20-1029	HG 14.298		
20-1003	HG 14.299	 Cabeza final 50 A (para todos los tipos) Cabeza final 100-225 A (para todos los tipos) Cabeza final 300A (para 3000, 6000 & GST) Cabeza final Underwater 100-300 A (6000, GST) Cabeza final aislada (para 3000, 6000 & GST) Cabeza final Underwater (para 6000)	
20-1004	HG 14.300		
20-1005	HG 14.301		
20-1006	HG 14.302		
20-1007	HG 14.303		
20-1028	HG 14.304		
Square Cut, 50A, O2-O2 recambios adecuados:			
20-1050	HG 14.305		Electrodo O2
20-0008	HG 14.306	Difusor Aire 50-225 A	
20-1051	HG 14.307	Boquilla 50 A	
20-1002	HG 14.308	Portaboquilla	
20-1052	HG 14.309	Protección cabeza final 50 A	

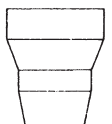
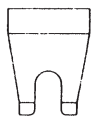
Codigo	N° Pedido	Descripción	
Recambios adecuados a Thermal Dynamics® PCH/M-40 Pak Master 50XL Plus			
2-5035 2-5036 2-5039 2-5040 4-0815 4-0816 4-2897 4-2898	HG 14.156 HG 14.157 HG 14.158 HG 14.159 HG 14.068 HG 14.069 HG 14.160 HG 14.161	Antorcha manual 25' - 7,5 m Antorcha manual 50' - 15 m Antorcha automatica 25' - 7,5 m Antorcha automatica 50' - 15 m Cables 25' - 7,5 m antorcha manual Cables 50' - 15 m antorcha manual Cables 25' - 7,5 m antorcha automatica Cables 50' - 15 m antorcha automatica	
8-0533	HG 1221A	 Junta tórica (para empuñadura) .	
9-8055 9-8059	HG 14.162 HG 14.065	 Cuerpo antorcha manual 70° Empuñadura completa con micro	
9-8053 9-7833	HG 14.163 HG 14.164	 Cuerpo antorcha automatica 180° Empuñadura automatica	
9-6506	HG 14.023	 Electrodo Hafnium, reforzado	
9-6507	HG 14.024	 Difusor Aire - Vespel®	
9-6500	HG 14.025	 Boquilla reforzada	
9-6501 9-6502	HG 14.026 HG 14.165	 Boquilla reforzada (drag cut) Boquilla scar	
9-6003	HG 14.003	 Portaboquilla Std	
9-6004	HG 14.004	 Portaboquilla almenada Para el correspondiente kit compás antorcha y accesorios véase pág. 3.	

Recambios adecuados a Thermal Dynamics® PCH/M-75, - 76 y - 100XL

Pak Master 75, Pak Master 75XL, 625XR, Cut Master 80XL, Econopak 100, Pak Master 100XL

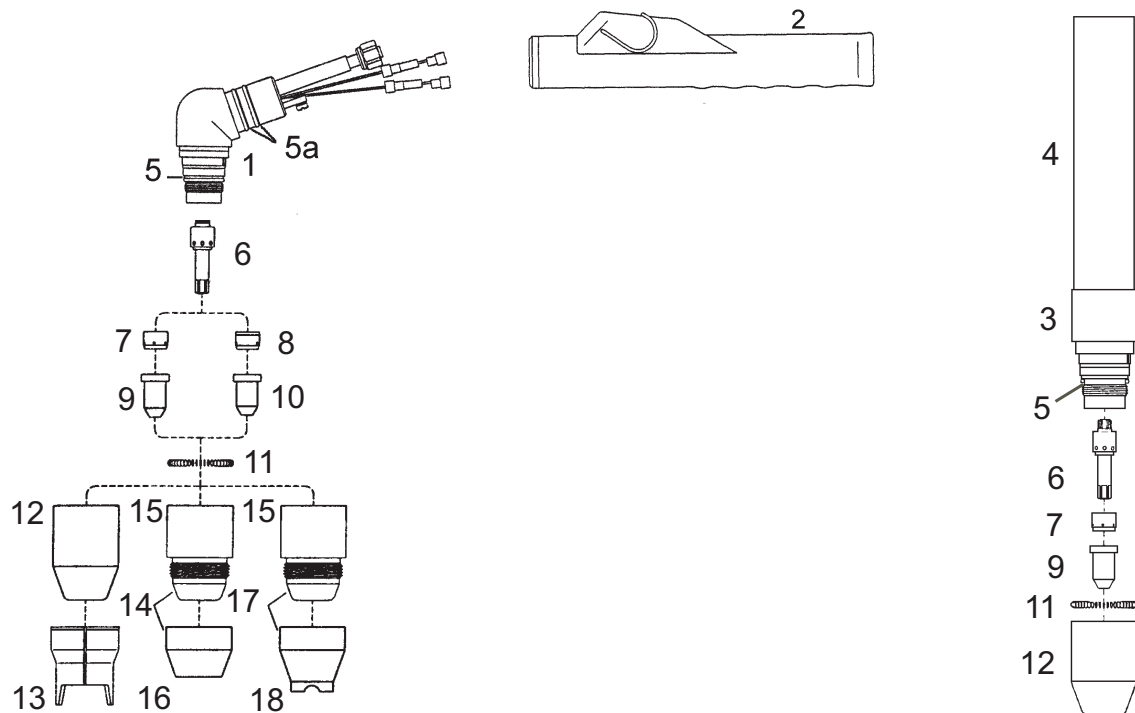

N°	Codigo	N° Pedido	Descripción
	2-7801	HG 14.031	Antorcha manual 25' - 7,5 m (codigos auxiliares 2-7811, 2-0801)
	2-7802	HG 14.032	Antorcha manual 50' - 15,0 m (codigos auxiliares 2-7812, 2-0802)
	2-7805	HG 14.050	Antorcha automatica 25' - 7,5 m (codigo auxiliar 2-0805)
	2-7806	HG 14.051	Antorcha automatica 50' - 15,0 m (codigo auxiliar 2-0806)
	4-7801	HG 14.047	Cables 25' -7,5m antorcha manual (codigos auxiliares 4-0810, 4-7611).....
	4-7802	HG 14.048	Cables 50' -15 m antorcha manual (codigos auxiliares 4-0811, 4-7612).....
	4-7803	HG 14.096	Cables 25' - 7,5 m antorcha automatica (codigo auxiliar 4-0812)
	4-7804	HG 14.097	Cables 50' - 15,0 m antorcha automatica (codigo auxiliar 4-0813)
1	8-7510	HG 14.033	Cuerpo antorcha manual 70°
2	9-5636E	HG 14.034	Empuñadura completa con micro plano
3	8-7512	HG 14.052	Corpo antorcha automatica 180° (no para PCH/M - 76)
4	9-5637E	HG 14.053	Empuñadura automatica (no para PCH/M - 76)
5	8-0532	HG 1221	Junta tórica (Portaboquilla)
5a	8-0533	HG 1221A	Junta tórica (Empuñadura)
6	8-7502	HG 14.036	Electrodo Hafnium
7	8-7501	HG 14.037	Difusor Aire boquilla
8	8-7508	HG 14.038	Difusor Aire boquilla scar
9	8-7503	HG 14.039	Boquilla Ø 0,99 - .039 35 A
	8-7504	HG 14.040	Boquilla Ø 1,17 - .046 55 A (noPCH/M - 76)
	8-7505	HG 14.041	Boquilla Ø 1,32 - .052 60-70 A (no PCH/M - 75)
10	8-7506	HG 14.042	Boquilla scar Ø 1,86 - .073
11	9-7501E	HG 14.043	Muelle espiral
12	8-7500	HG 14.044	Portaboquilla
13	8-7575	HG 14.049	Boquilla 2 patas
14	8-7496	HG 14.174	Portaboquilla completa, long life
15	8-7498	HG 14.045	Portaboquilla contacto
16	8-7497	HG 14.098	Potaboquilla corte automatico (Cobre)
17	8-7507	HG 14.175	Portaboquilla almenada contacto completa, Set
18	8-7499	HG 14.046	Portaboquilla almenada contacto (Cobre)

Para los correspondientes kit compás y accesorios véase pág. 3.

© Copyright 2009 by HOLMA® Switzerland. Todos los derechos reservados.

Página 11